



**gemini**  
ITALY

**SLOW JUICER**  
**慢磨榨汁機**

MODEL NO 型號: GSJ15S  
150W



A GILMAN GROUP BRAND

## **SAFETY INSTRUCTIONS - GENERAL**

- Please read these instruction carefully and retain them for future reference.
- Use this appliance solely in accordance with these instructions.
- This appliance is for household use only, not for commercial purpose.
- Remove all packaging material from the appliance before use.
- This appliance shall not be used by children of 0 to 8-year old.
- This appliance can be used by children older than 8-year old and persons with reduced physical, sensory or mental capabilities or lack of experience and knowledge, but only if they have been given supervision or instruction concerning use of the appliance in safe way and understand the hazards involved.
- Children should be supervised to ensure that they do not play with the appliance.
- Cleaning and maintenance must not be done by children.
- Keep the appliance and the cable out of reach of children.
- Have any repairs carried out solely by a qualified electrician. Never try to repair the appliance yourself.
- Do not handle the plug or appliance with wet hands.
- Do not immerse the main body in water.
- Do not touch moving parts.
- Children shall not play with the appliance.
- Do not leave the appliance unattended when connected to the mains supply.
- Keep hair, loose clothing, fingers and all parts of the body away from openings of the appliance.
- Only use the attachments/accessories supplied with the product.
- The parts and accessories are not suitable for cleaning in a dishwasher.

## **SAFETY INSTRUCTIONS - ELECTRICITY**

- Do not insert objects into the appliance when operating. If fruit becomes lodged or blocked, press switch “R” for 2 - 3 seconds before disassembling and cleaning.
- Do not operate the appliance when it is empty.
- Do not use fingers, rice ladle and cropsticks to push the ingredients to the feed chute on the hopper.
- Verify that the mains voltage is the same as that indicated on the rating plate on the appliance before use.
- Make sure that you always use a grounded wall socket to connect the appliance.
- Always remove the plug from the wall socket when the appliance is not in use.
- Remove the plug from the wall socket by pulling the plug, not the power cord.
- Make sure that the power cord and plug do not make contact with water.
- Make sure that the appliance, the power cord and plug do not make contact with hot surface, such as a hot hob or naked flame.

- Check the appliance's power cord regularly to make sure it is not damaged.
- Do not use the appliance if the power cord is damaged. If the power cord is damaged, it must be replaced by an electrical technician or a person with similar qualification, in order to avoid any hazards.
- Never use the appliance in the vicinity of flammable material.



**NOTE: The maximum operating time is 20 minutes. Waiting for another 20 minutes for cooling before next use. Do not exceed this time or it will damage the motor.**

# PRODUCT REVIEW

- 1a. Top of Hopper
- 1b. Hopper
- 2. Squeezing Screw
- 3. Strainer
- 4. Spinning Rack
- 5. Juicing Jug
- 6. Main unit
- 7. Cleaning Brush
- 8. Pusher
- 9. Pulp Cup
- 10. Juice Cup
- 11. Juice Outlet Stopper

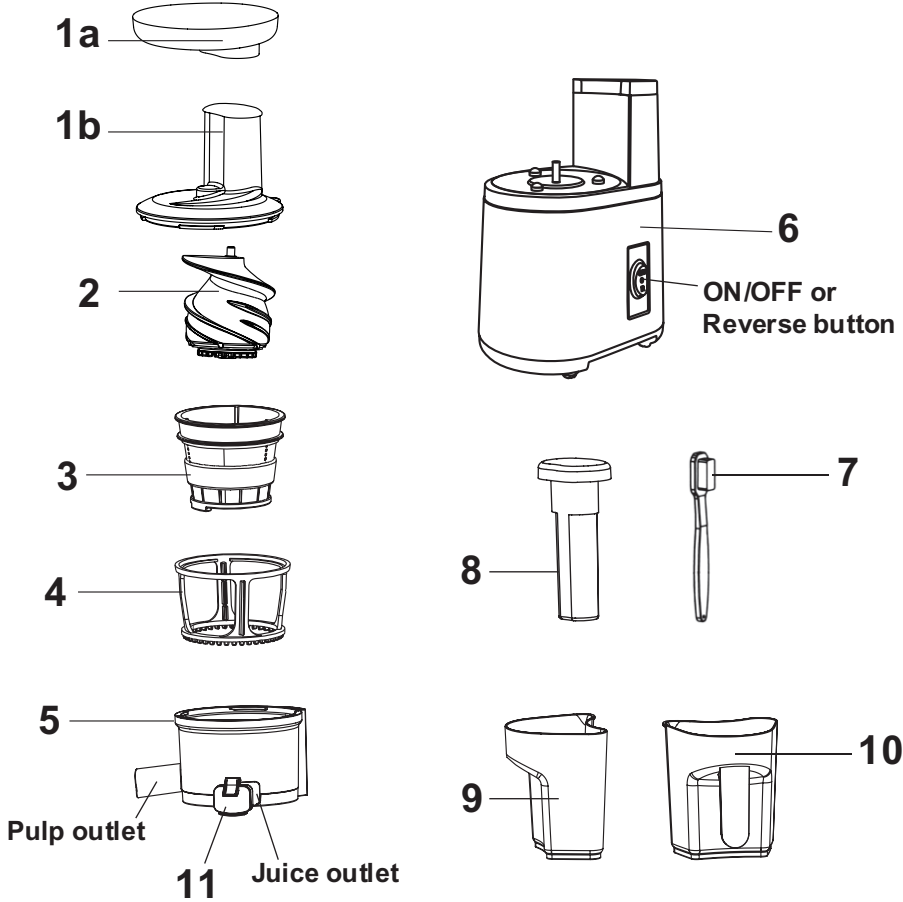

## ASSEMBLING YOUR SLOW JUICER

1. Fit the juicing jug to the main unit by aligning the 3 location pins of the jug and main unit. (see below image)

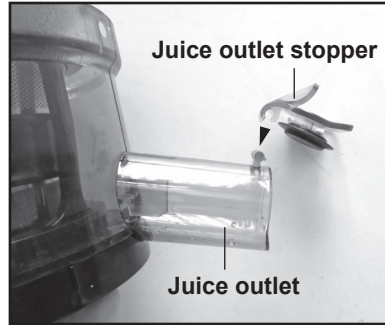
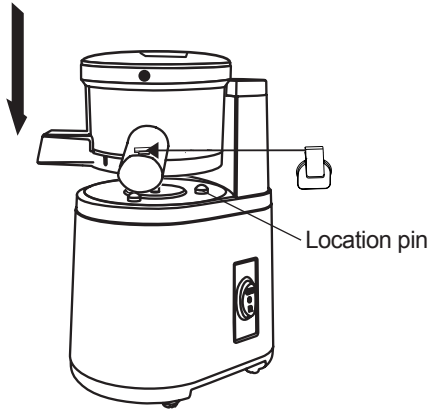

\*Insert the "C" lock area of juice outlet stopper to the embossed part of juice outlet as above position. Make sure the joint is interlocked before operation.

2. Fit the top of hopper into hopper.

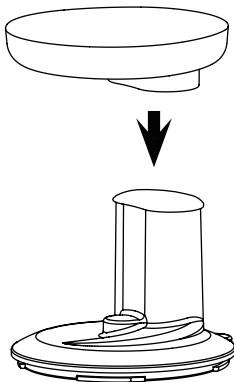

3. Fit the strainer into spinning rack.

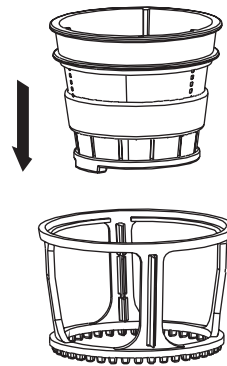

4. Insert the strainer and spanning rack into the juicing jug (refer the step of TIPS below) and turn until it locates in position.

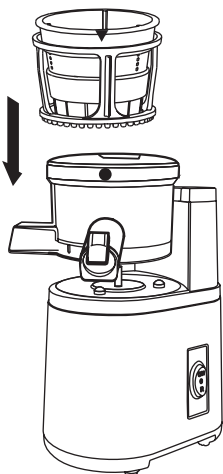

**TIPS:**



Ensure the arrow of the strainer and white dot on the jug should be aligned and hold in position as above image.

5. Insert the squeezing screw into the strainer and turn until it locates in position.

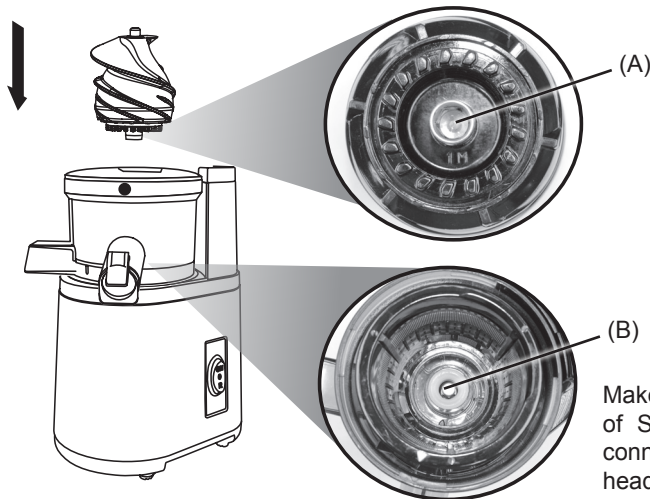

Make sure the hexagon slot (A) of Squeezing Screw perfectly connect to the hexagon driving head (B) on juicing jug

6. Lock the hopper to the top of the jug, aligning the arrows  on the hopper and the jug as below diagrams.

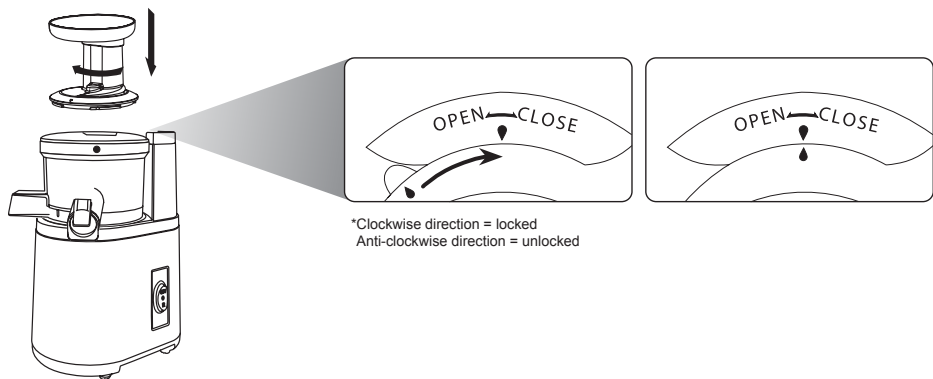

Twist the hopper in clockwise direction on juicing jug until both arrows are locked in right position.

There is a safety switch to protect the user. The unit will only start operation when the hopper is locked in place.

## INSTALLATION OF RUBBER PLUG

Pull out the rubber plug slightly and clean. After clean, re-install the rubber plug according to the diagram below.

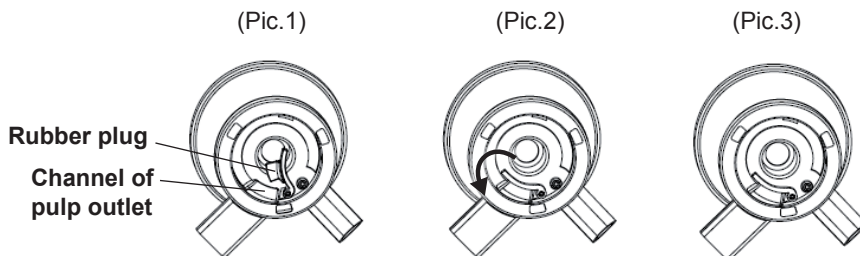

1. Pull out the rubber plug by clockwise direction from the channel of pulp outlet which located in bottom of juicing jug. (Pic.1)
2. After cleaning, insert the rubber plug into channel of pulp outlet to anti-clockwise direction. (Pic.2)
3. Make sure the channel of pulp outlet is closed tightly. (Pic.3)

**Caution:** The rubber plug must be placed correctly. Otherwise, the jug will have leakage problem.

## HOW TO USE YOUR SLOW JUICER

- Before first use, clean all removable parts in warm soapy water and dry thoroughly.
- Ensure that the slow juicer is correctly assembled.
- Position the pulp cup under the pulp outlet on the left of the unit and position the juice cup under the juice outlet on the right of the unit.
- Prepare your ingredients by cutting and de-seeding them if required.
- Plug the slow juicer into the mains socket.
- Insert your prepared ingredients into the feed chute on the hopper.
- Switch on the juicer with the switch at the side of the unit.
- If there is a blockage in the juicer, stop the juicer immediately. The reverse function “R” can be used to help unblock and clear the obstruction. When the obstruction has been cleared, the parts should be cleaned thoroughly before using again.
- After operation, please press switch “R” for 2-3 seconds before disassembling and cleaning.

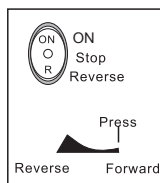

**ON:** Start the juicer  
**O:** Stop the operation  
**R:** Reverse the operation

**Do not attempt to juice hard ingredients / food such as seeds, pips, ice or frozen foods, this will damage the unit.**

- Always clean the juicer and the parts using the brush provided after each use.
- Do not overfill the hopper. Insert vegetables / fruit slowly to allow the juicer time to work. The pusher should only be used if vegetables / fruit becomes lodged. Push down gently.
- Vegetables must be cut into pieces less than 2 cm length.
- Carrots must be cut into strips and the diameter must be less than 2 cm.

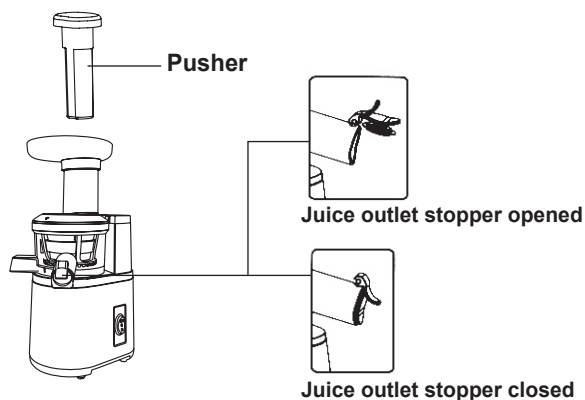

**NOTE:** The maximum operating time is 20 minutes. Waiting for another 20 minutes for cooling before next use. Do not exceed this time or it will damage the motor.



## CLEANING

- Periodically clean the rubber parts of the spinning rack.
- Thoroughly clean all parts immediately after every use to maintain the performance of the product.
- After operation, please press switch “R” for 2 - 3 seconds before disassembling and cleaning.
- Do not use harsh chemicals or abrasives to clean the parts of the juicer.
- Never clean the parts in a dishwasher as **this will damage the parts.**
- Rubber plug located in bottom of juicing jug need to clean properly after use. (Refer to Page 7 “INSTALLATION OF RUBBER PLUG”)

## TROUBLESHOOTING GUIDE

Problem	Possible Cause	What To Do
No function of juicer.	Juicer is not plugged in.	Check the juicer is plugged in.
	Incorrect assembly.	Re-assemble the juicer as per the instructions. Ensure the lid is locked correctly.
The motor has stopped.	There is a blockage in the juicing jug.	Press the reverse button to clear the blockage.
	The motor has cut out due to over-use.	Switch off, unplug and allow to cool down for 10 minutes before using again.
Leaking underneath the juicing jug.	The rubber plug is not correctly inserted.	Remove all parts and check the position of the rubber plug.
Staining on parts.	This is the natural color from juice.	This is normal. To reduce discolouration, ensure you rinse and clean the appliance immediately after use.
Squeaking noise when juicing.	Friction between the squeezing screw and juicing jug or food / fruit.	The squeaking sound is perfectly normal. Do not operate the juicer without any ingredients.
Too much pulp coming out with juice.	There is excess food / fruit in the juicing jug clogging the strainer.	Cut food / fruit, especially fibrous food into smaller pieces.

## PRODUCT SPECIFICATION

Model No.: GSJ15S  
 Voltage: 220-240V  
 Frequency: 50/60Hz  
 Power: 150W  
 Product dimension: 165(W) x 410(H) x 210(D) mm

閱讀下列說明事項並請妥善保管，以供日後參考。

## 一般安全

在使用本產品之前，應仔細閱讀下列事項及使用說明，閱後並請妥善保管，以供日後參考：

- 請按照這些說明事項，使用本產品。
- 本產品僅供家用，不作商業用途。
- 使用前，請將所有包裝材料。
- 0至8歲的兒童不應使用本產品。
- 超過8歲的兒童可使用本產品，但請勿由肢體不健全、感覺或精神上有障礙或缺乏相關經驗和知識的人使用，除非有負責他們安全的人對他們使用本產品進行監督或指導。
- 請務必看顧好兒童，以確保他們不玩耍本產品。
- 兒童不應清潔或維修本產品。
- 當需進行任何維修，必須由專業維修人員進行維修。永遠不要嘗試自己修理本產品。
- 手濕時不可以接觸電源插頭或本機。
- 主體不可以浸入水中。
- 不可接觸轉動中的零件。
- 兒童不可以把玩本機。
- 本機開著後不可以無人監管。
- 當本機開著時，頭髮、鬆身衣物、手指和身體其他部份都要離開本機。
- 只可以使用隨機附件。
- 本機的零件和配件都不適合放入洗碗碟機清洗。

## 安全指引-電子產品

- 本機開動時不可以插入物件，如果在榨汁杯中的蔬果已把本機出汁口 / 出渣口塞住，請按“R”按鈕 2 - 3 秒後才拆開相關部件進行清潔。
- 本機內沒有食物時不要開動本機。
- 機體的進料口禁止用手指、飯勺、筷子把蔬果推進。
- 使用相符的電源和電壓，以防止觸電。
- 本產品只能使用帶接地線的電源插座。
- 當本產品不使用時，請從牆上的插座中拔掉插頭。
- 從牆上插座中拔掉插頭時，應拿著插頭而不是電源線。
- 確保本產品的電源線和插頭不與水接觸。

- 確保本產品、電源線和插頭不接觸發熱表面，如明火。
- 定期檢查本產品的電源線以確保其未損壞。如果電源線損壞，請勿使用其產品，並須由專業維修人員來更換，以避免出現任何險。
- 切勿在易燃材料附近使用本產品。



最長使用時間為20分鐘，待20分鐘冷卻後才可再次使用，過長時間會損壞本機

## 部件示意圖

- 1a. 榨汁杯蓋上蓋
- 1b. 榨汁杯蓋
2. 螺旋推進器
3. 榨汁筒
4. 旋轉架
5. 榨汁杯
6. 主機
7. 清洗刷
8. 推進杆
9. 接渣杯
10. 接汁杯
11. 出汁口蓋

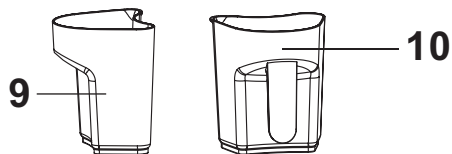
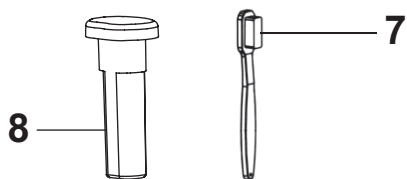
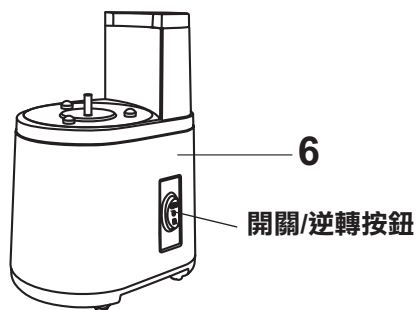
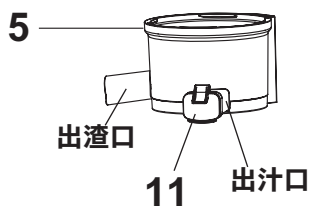
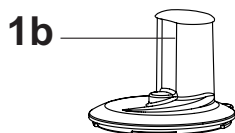
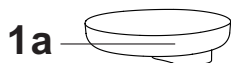

## 安裝方法

1. 將榨汁杯底部的3個定位孔垂直裝在主機突起的定位柱上。  
(如下圖)

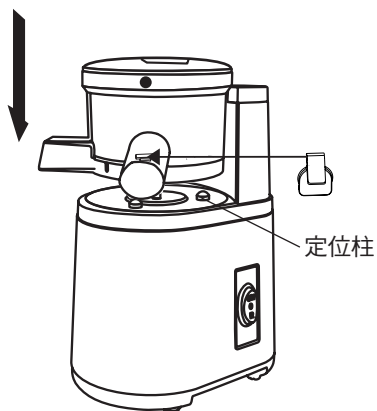

\*將出汁口蓋上的“C”字型扣位安裝到出汁口上的凸起位置。確定出汁口蓋能完全緊密封好出汁口才可使用。(如上圖)

2. 將榨汁杯蓋上蓋放入榨汁杯蓋中。

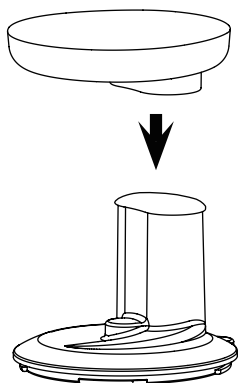

3. 將榨汁筒放入旋轉架中。

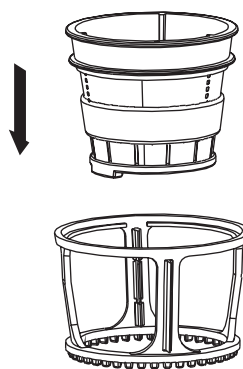

4. 將榨汁筒及旋轉架安裝到榨汁杯上，並確保安裝位置準確。  
(如下圖)

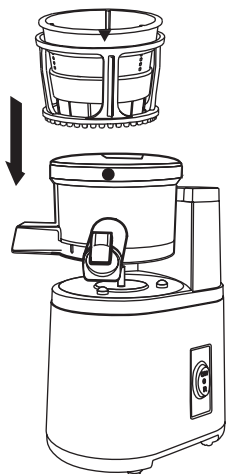

小貼士：



確保榨汁筒上的箭頭標示和榨汁杯上的白色圓點對準並緊扣到位。(如上圖)

5. 將螺旋推進器向下方安裝到榨汁筒中間。

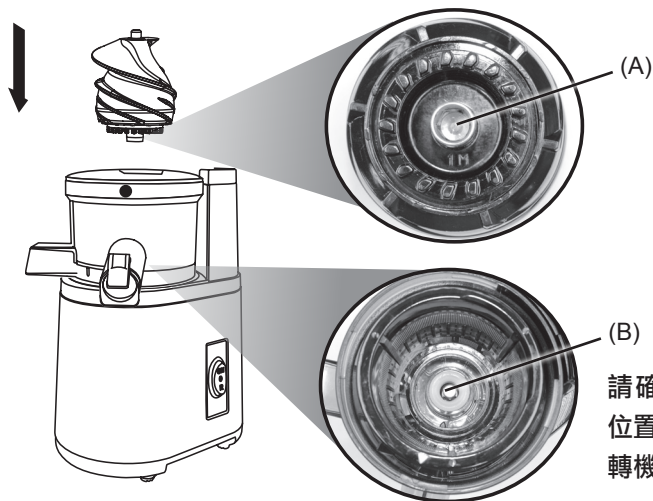

請確保螺旋推進器的六角形位置 (A) 和主機上的六角形旋轉機頭 (B) 完全連接

6. 安裝榨汁蓋，對好榨汁蓋和榨汁杯的標示。

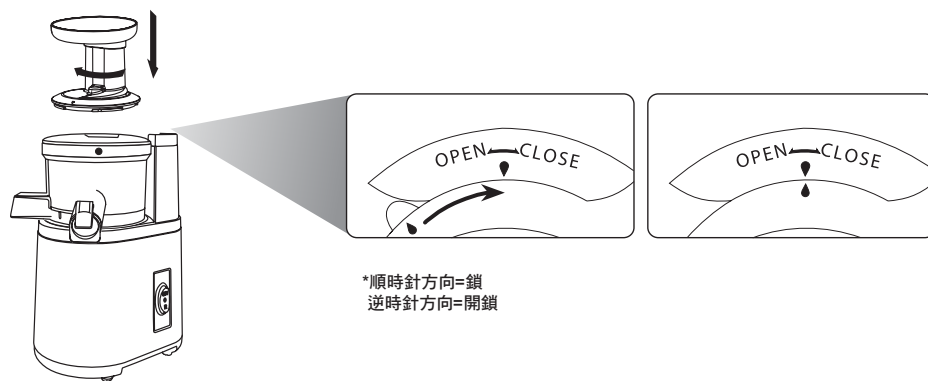

順時針轉動榨汁蓋直至箭咀對齊和卡到位。

在主機內有保險掣，若保險掣沒有扣好是不能開啓本機。

## 橡膠墊的安裝方法

輕輕地拔出橡膠墊清洗後，請按下圖安裝。

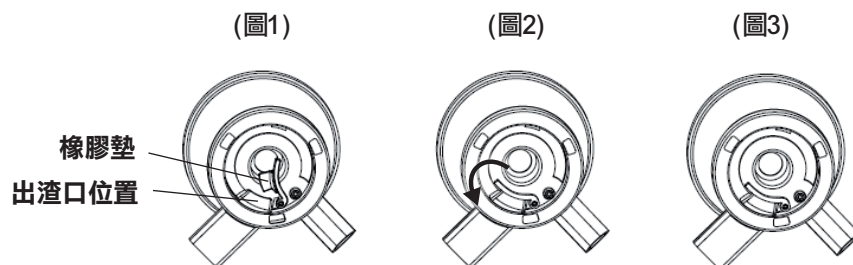

1. 把橡膠墊以順時針方向從榨汁杯底部出渣口位置取出 (圖1)
2. 清洗抹乾淨後，把橡膠墊以逆時針方向套入出渣口位置 (圖2)
3. 確定出渣口被橡膠墊緊密封閉為止 (圖3)

注意：橡膠墊務必安裝到位，否則會出現漏汁問題。

## 使用方法

- 第一次使用前，請用暖肥皂水清潔所有可拆開的零件，待乾
- 確保本機已正確安裝
- 把接渣杯放在左面的出渣口下方，接汁杯放在右面的出汁口下方
- 預備所需材料及去果核
- 然後接上電源
- 把預備好的材料切成適當大小，放入榨汁蓋中的進料口
- 按下機旁的開關“ON”，開動本機
- 如果榨汁過程中有阻塞的情況，請立即關機，按下機旁開關擊的“R”位，這會把阻塞物鬆開，然後關機並請把本機的阻塞物清理後再用
- 使用後，請長按“R”按鈕 2 - 3 秒後才拆開相關部件進行清潔

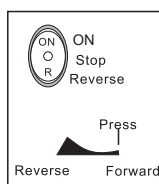

**ON:** 按此開始榨汁

**O:** 停止操作

**R:** 逆轉操作

**請不要放入硬物如果核、冰或已結冰的食物，這會損壞本機。**

- 經常使用本機附送的刷來清潔
- 不可放太多蔬菜 / 生果入榨汁蓋，每次放入小量，有少許卡住時可用推進杆，輕輕按下幫助推動蔬果於榨汁筒內
- 蔬菜必須切成少於2厘米的長度
- 胡蘿蔔必須切成條狀，直徑必須少於 2 厘米

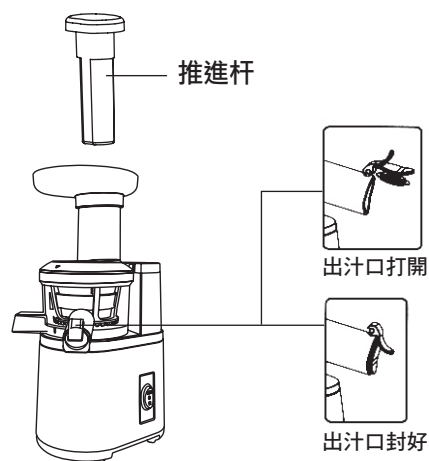

最長使用時間為20分鐘，待20分鐘冷卻後才可再次使用，過長時間會損壞本機



## 清潔方法

- 定期清潔旋轉架的橡膠零件
- 當使用完後立即清理所有部件
- 使用後，請長按“R”按鈕 2 - 3 秒後才拆開相關部件進行清潔
- 不要有磨損性的清潔劑和工具清潔本機及配件
- 不要把配件放入洗碗碟機內清洗，這會使配件損壞
- 每次榨汁後，均要徹底清洗位於榨汁杯上的橡膠墊  
(請參考第十五頁“橡膠墊的安裝方法”)

## 故障檢查與處理

現象	原因	處理方法
本機不動	沒有接上電源	確認已接上電源
	不正確安裝	依說明書方法重新安裝一次，榨汁蓋必須安裝到位
摩打停下	榨汁杯內阻塞	按下“R”逆轉掣把阻塞物鬆開
	開動超時	關機和拔除電源插頭，待10分鐘冷卻後再開動
榨汁杯底漏水	橡膠墊沒有安裝好	移除各配件後把橡膠墊裝好
配件上有染色	這是果汁的正常顏色	這是正常的，使用後立即清潔可以減小染色問題
有異常噪音	榨汁時零部件發出擠壓的聲音	這是正常的，但不要在沒有食物 / 蔬果時開動本機
大量渣和汁一同流出	有太多大件食物 / 蔬果在榨汁杯中	把食物 / 蔬果切細件

## 產品規格

型號: GSJ15S  
電壓: 220-240V  
頻率: 50/60Hz  
功率: 150瓦  
產品尺寸: 165(闊) x 410(高) x 210(深) 毫米





請記錄下列產品資料

- 型號

---

- 機身編號

---

- 經銷商名稱

---

- 購買日期

---

本產品不斷改進中，如功能有所更改，恕不另行通知，如有疑問，請與客戶服務中心聯絡，不便之處，敬請原諒。

說明書內容以英文版本為準

**ToolBox Customer Service Centre 客戶服務中心：**  
4/F, DCH Building, 20 Kai Cheung Road, Kowloon Bay, Hong Kong  
香港九龍灣啓祥道20號大昌行集團大廈4樓

Customer Service Hotline 客戶服務熱線：(852) 8210 8210  
Service E-mail 電郵地址：8210service@gilman-group.com  
Please register now at 請即上網登記：www.toolbox.hk  
Website 網址：www.gilman-group.com



Proudly Serviced by:



**太平家庭電器**